

Eddy Currents

Introduction

Induced eddy currents and associated thermal loads are of interest in many high power AC applications. This example is of general nature and illustrates some of the involved physics as well as suitable modeling techniques in the AC/DC Module.

Model Definition

A metallic plate is placed near a 50 Hz AC conductor. The resulting eddy current distribution in the plate depends on the conductivity and permeability of the plate. In the discussion, four different materials are considered: copper, aluminum, stainless steel, and magnetic iron. The step-by-step instructions focus on copper and iron. The geometry consists of a single wire and a plate with dimensions as shown in [Figure 1](#).

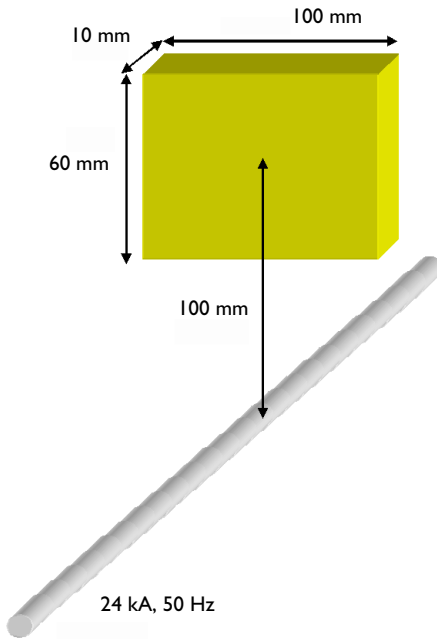

Figure 1: The model geometry.

Because one cannot afford meshing an infinite volume, it is necessary to specify a finite volume to mesh and solve for. In this case, it makes sense to enclose the wire and the plate in a cylinder with the wire on the cylinder axis. This is a good choice when used with the default boundary condition, Magnetic Insulation, which forces the field to be tangential

to the exterior boundaries. For the cylindrical shape of the domain, that is a reasonable approximation to reality. The conductor is modeled as a line current with 0° phase and an effective (RMS) value of 24 kA.

The magnetic vector potential is calculated from

$$(j\omega\sigma - \omega^2\varepsilon)\mathbf{A} + \nabla \times \left(\frac{1}{\mu} \nabla \times \mathbf{A} \right) = \mathbf{0}$$

where σ is the conductivity, ε the permittivity, and μ the permeability. An important parameter in eddy current modeling is the skin depth, δ .

$$\delta = \sqrt{\frac{2}{\omega\mu\sigma}}$$

The following table lists the skin depth for the different materials at a frequency of 50 Hz.

MATERIAL	REL. PERMEABILITY	CONDUCTIVITY	SKIN DEPTH
Copper	1	$5.998 \cdot 10^7$ S/m	9 mm
Aluminum	1	$3.774 \cdot 10^7$ S/m	12 mm
Stainless steel	1	$1.137 \cdot 10^6$ S/m	67 mm
Iron	4000	$1.12 \cdot 10^7$ S/m	0.34 mm

In order for the model to produce accurate results, the mesh needs to resolve the evanescent fields in the metal. In practice, this means you need to resolve the skin depth with at least more than 1 element, preferably closer to 2, or even more. This application uses a maximum element size of 5 mm for the copper plate.

When the skin depth is small in comparison to the size of the conducting objects, it can be practically impossible to resolve it. This often happens at high frequencies, in large structures, or with highly conductive and permeable materials. These cases require a different technique: Exclude the interior of the conducting objects from the model. Instead, represent them with an impedance boundary condition. This condition essentially sets the skin depth to zero, making all induced currents flow on the surface of the conductors. Mathematically, the relation between the magnetic and electric fields at the boundary reads:

$$\mathbf{n} \times \mathbf{H} + \sqrt{\frac{\varepsilon - j\sigma/\omega}{\mu}} \mathbf{n} \times (\mathbf{E} \times \mathbf{n}) = \mathbf{0}$$

The dissipated power density, P_d (SI unit: W/m^2) can be calculated from

$$P_d = \frac{1}{2}(\mathbf{J}_S \cdot \mathbf{E}^*)$$

where \mathbf{J}_S is the induced surface current density, and the asterisk (*) denotes the complex conjugate.

This model has the interior of the plate included in the model for copper, and uses the impedance boundary condition for magnetic iron.

Results and Discussion

In [Figure 2](#), the induced eddy current distribution for a plate made of copper is shown as streamlines, whereas the distribution of the ohmic losses is shown as a slice plot.

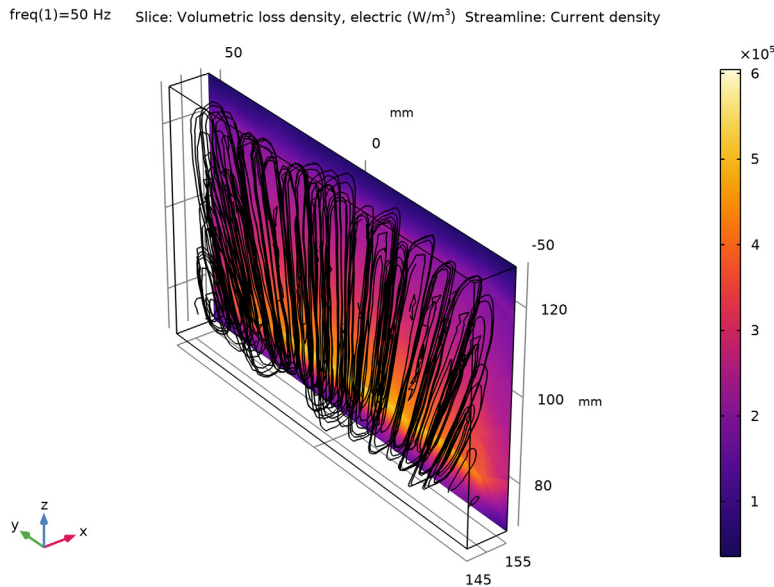

Figure 2: Induced eddy current distribution and losses in the copper plate.

A total dissipated power of 6 W was obtained from integration through the plate. If you repeat the simulation for different materials, the application shows that lowering the conductivity decreases the dissipated power. However, for high permeability materials like soft iron, the dissipated power is higher than in copper (27 W) despite a much lower conductivity.

Application Library path: ACDC_Module/Introductory_Electromagnetics/
eddy_currents



Modeling Instructions

From the **File** menu, choose **New**.

NEW

In the **New** window, click  **Model Wizard**.

MODEL WIZARD

- 1 In the **Model Wizard** window, click  **3D**.
- 2 In the **Select Physics** tree, select **AC/DC** > **Electromagnetic Fields** > **Magnetic Fields (mf)**.
- 3 Click **Add**.
- 4 Click  **Study**.
- 5 In the **Select Study** tree, select **General Studies** > **Frequency Domain**.
- 6 Click  **Done**.

GEOMETRY I

- 1 In the **Model Builder** window, under **Component 1 (comp1)** click **Geometry 1**.
- 2 In the **Settings** window for **Geometry**, locate the **Units** section.
- 3 From the **Length unit** list, choose **mm**.

Cylinder 1 (cyl1)



- 1 In the **Geometry** toolbar, click  **Cylinder**.
- 2 In the **Settings** window for **Cylinder**, locate the **Size and Shape** section.
- 3 In the **Radius** text field, type 250.
- 4 In the **Height** text field, type 300.
- 5 Locate the **Axis** section. From the **Axis type** list, choose **Cartesian**.
- 6 In the **x** text field, type 1.
- 7 In the **z** text field, type 0.

Line Segment 1 (ls1)

- 1 In the **Geometry** toolbar, click  **More Primitives** and choose **Line Segment**.

- 2 In the **Settings** window for **Line Segment**, locate the **Starting Point** section.
- 3 From the **Specify** list, choose **Coordinates**.
- 4 Locate the **Endpoint** section. From the **Specify** list, choose **Coordinates**.
- 5 In the **x** text field, type 300.
- 6 Click  **Build All Objects**.

Block 1 (blk1)

- 1 In the **Geometry** toolbar, click  **Block**.
- 2 In the **Settings** window for **Block**, locate the **Size and Shape** section.
- 3 In the **Width** text field, type 10.
- 4 In the **Depth** text field, type 100.
- 5 In the **Height** text field, type 60.
- 6 Locate the **Position** section. In the **x** text field, type 145.
- 7 In the **y** text field, type -50.
- 8 In the **z** text field, type 70.
- 9 Click  **Build All Objects**.
- 10 Click the  **Transparency** button in the **Graphics** toolbar.

The model geometry is now complete. Prepare your simulation by defining selections.

DEFINITIONS

Plate



- 1 In the **Definitions** toolbar, click  **Explicit**.
- 2 In the **Settings** window for **Explicit**, type Plate in the **Label** text field.
- 3 Select Domain 2 only.

Plate Boundaries

- 1 In the **Definitions** toolbar, click  **Explicit**.
- 2 In the **Settings** window for **Explicit**, type Plate Boundaries in the **Label** text field.
- 3 Select Domain 2 only.
- 4 Locate the **Output Entities** section. From the **Output entities** list, choose **Adjacent boundaries**.

ADD MATERIAL

- 1 In the **Materials** toolbar, click  **Add Material** to open the **Add Material** window.

- 2 Go to the **Add Material** window.
- 3 In the tree, select **Built-in > Copper**.
- 4 Click the **Add to Component** button in the window toolbar.
- 5 In the **Materials** toolbar, click  **Add Material** to close the **Add Material** window.

MATERIALS

Copper (mat1)

- 1 In the **Settings** window for **Material**, locate the **Geometric Entity Selection** section.
- 2 From the **Selection** list, choose **Plate**.

MAGNETIC FIELDS (MF)

Ampère's Law in Solids 1

- 1 In the **Physics** toolbar, click  **Domains** and choose **Ampère's Law in Solids**.
- 2 In the **Settings** window for **Ampère's Law in Solids**, locate the **Domain Selection** section.
- 3 From the **Selection** list, choose **Plate**.
- 4 In the list, select **2**.

Edge Current 1

- 1 In the **Physics** toolbar, click  **Edges** and choose **Edge Current**.
- 2 Select Edge 6 only.
- 3 In the **Settings** window for **Edge Current**, locate the **Edge Current** section.
- 4 In the I_0 text field, type $\text{sqrt}(2) * 24[\text{kA}]$, resulting in an RMS current of 24 kA.

MESH 1

To resolve the skin depth while maintaining a good mesh economy, mesh the copper plate finer than the rest of the geometry. Note that you need to add the finer mesh first in the sequence; otherwise you would get a coarse mesh on the common domain boundaries that would constrain the mesh inside the copper plate domain.

Free Tetrahedral 1

- 1 In the **Mesh** toolbar, click  **Free Tetrahedral**.
- 2 In the **Settings** window for **Free Tetrahedral**, locate the **Domain Selection** section.
- 3 From the **Geometric entity level** list, choose **Domain**.
- 4 From the **Selection** list, choose **Plate**.
- 5 Click to expand the **Scale Geometry** section. In the **y-direction scale** text field, type **0.4**.

6 In the **z-direction scale** text field, type 0.4.

Size 1

- 1 Right-click **Free Tetrahedral 1** and choose **Size**.
- 2 In the **Settings** window for **Size**, locate the **Element Size** section.
- 3 Click the **Custom** button.
- 4 Locate the **Element Size Parameters** section.
- 5 Select the **Maximum element size** checkbox. In the associated text field, type 5.

Free Tetrahedral 2

- 1 In the **Mesh** toolbar, click  **Free Tetrahedral**.
- 2 In the **Model Builder** window, right-click **Mesh 1** and choose **Build All**.

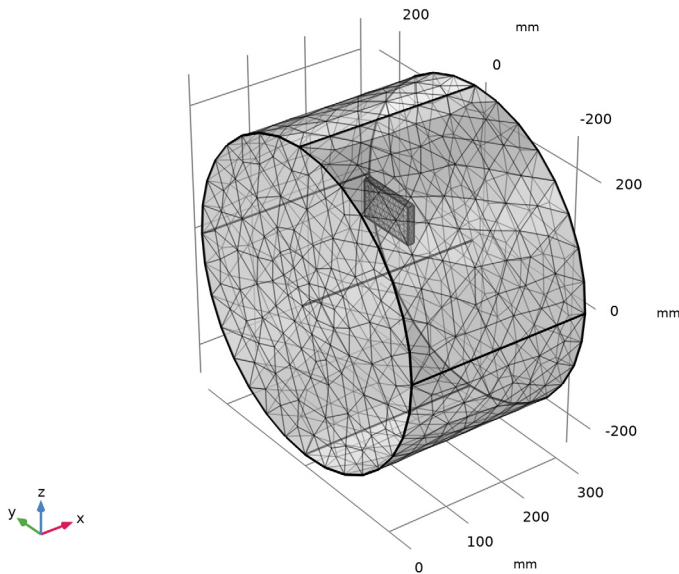

STUDY 1

Step 1: Frequency Domain

- 1 In the **Model Builder** window, under **Study 1** click **Step 1: Frequency Domain**.
- 2 In the **Settings** window for **Frequency Domain**, locate the **Study Settings** section.
- 3 In the **Frequencies** text field, type 50.
- 4 In the **Study** toolbar, click  **Compute**.

RESULTS

Magnetic Flux Density (mf)

The default plot shows the magnetic flux density norm in three cross sections. The following instructions show you how to visualize the eddy currents and the resistive heating in the copper plate.



Study 1/Solution 1 (2) (sol1)

- 1 In the **Model Builder** window, expand the **Results > Datasets** node.
- 2 Right-click **Results > Datasets > Study 1/Solution 1 (sol1)** and choose **Duplicate**.

Selection

- 1 In the **Results** toolbar, click  **Attributes** and choose **Selection**.
- 2 In the **Settings** window for **Selection**, locate the **Geometric Entity Selection** section.
- 3 From the **Geometric entity level** list, choose **Domain**.
- 4 From the **Selection** list, choose **Plate**.

Switch from transparency to wireframe rendering.

- 5 Click the  **Transparency** button in the **Graphics** toolbar.
- 6 Click the  **Wireframe Rendering** button in the **Graphics** toolbar.

Eddy Currents and Heating

- 1 In the **Results** toolbar, click  **3D Plot Group**.
- 2 In the **Settings** window for **3D Plot Group**, type Eddy Currents and Heating in the **Label** text field.
- 3 Locate the **Data** section. From the **Dataset** list, choose **Study 1/Solution 1 (2) (sol1)**.

Slice 1

- 1 Right-click **Eddy Currents and Heating** and choose **Slice**.
- 2 In the **Settings** window for **Slice**, click **Replace Expression** in the upper-right corner of the **Expression** section. From the menu, choose **Component 1 (comp1) > Magnetic Fields > Heating and losses > mf.Qrh - Volumetric loss density, electric - W/m³**.
- 3 Locate the **Plane Data** section. From the **Entry method** list, choose **Coordinates**.
- 4 In the **x-coordinates** text field, type 154.9.
- 5 Locate the **Coloring and Style** section. From the **Color table** list, choose **HeatCamera**.
- 6 In the **Eddy Currents and Heating** toolbar, click  **Plot**.

Streamline 1

- 1 In the **Model Builder** window, right-click **Eddy Currents and Heating** and choose **Streamline**.
- 2 In the **Settings** window for **Streamline**, click **Replace Expression** in the upper-right corner of the **Expression** section. From the menu, choose **Component 1 (comp1) > Magnetic Fields > Currents and charge > mf.Jx,mf.Jy,mf.Jz - Current density**.
- 3 Locate the **Streamline Positioning** section. From the **Positioning** list, choose **Uniform density**.
- 4 In the **Separating distance** text field, type 0.06.
- 5 Locate the **Coloring and Style** section. Find the **Point style** subsection. From the **Color** list, choose **Black**.



Zoom in to get a better view of the results.

Eddy Currents and Heating

- 1 In the **Model Builder** window, click **Eddy Currents and Heating**.
- 2 In the **Eddy Currents and Heating** toolbar, click  **Plot**.

As a final step, integrate the resistive heating in the copper to compute the total heating power.

Volume Integration 1

- 1 In the **Results** toolbar, click  **More Derived Values** and choose **Integration > Volume Integration**.
- 2 In the **Settings** window for **Volume Integration**, locate the **Selection** section.
- 3 From the **Selection** list, choose **Plate**.
- 4 Click **Replace Expression** in the upper-right corner of the **Expressions** section. From the menu, choose **Component 1 (comp1) > Magnetic Fields > Heating and losses > mf.Qrh - Volumetric loss density, electric - W/m³**.
- 5 Click  **Evaluate**.

The result should be close to 6 W.

If you would like to repeat the analysis for aluminum or some other material with a skin depth of the order of 1 cm or greater, just change the material in the plate and run the simulation again. In the remaining part of this tutorial, the **Impedance Boundary Condition** will be used to compute the results for magnetic iron, which has a skin depth far less than the thickness of the plate.

MAGNETIC FIELDS (MF)



- 1 In the **Model Builder** window, under **Component 1 (comp1)** click **Magnetic Fields (mf)**.
- 2 In the **Settings** window for **Magnetic Fields**, locate the **Domain Selection** section.
- 3 From the **Selection** list, choose **Manual**.
- 4 Select Domain 1 only.

Removing the plate means no equations will be solved inside it. Add an **Impedance Boundary Condition** to switch to a surface representation instead.

Impedance Boundary Condition 1

- 1 In the **Physics** toolbar, click  **Boundaries** and choose **Impedance Boundary Condition**.
- 2 In the **Settings** window for **Impedance Boundary Condition**, locate the **Boundary Selection** section.
- 3 From the **Selection** list, choose **Plate Boundaries**.

ADD MATERIAL

- 1 In the **Home** toolbar, click  **Add Material** to open the **Add Material** window.
- 2 Go to the **Add Material** window.
- 3 In the tree, select **Built-in > Iron**.
- 4 Click the **Add to Component** button in the window toolbar.
- 5 In the **Home** toolbar, click  **Add Material** to close the **Add Material** window.

MATERIALS

Iron (mat2)

- 1 In the **Settings** window for **Material**, locate the **Geometric Entity Selection** section.
- 2 From the **Geometric entity level** list, choose **Boundary**.
- 3 From the **Selection** list, choose **Plate Boundaries**.

STUDY 1

In order to keep the results for copper, disable **Solver 1** before computing the study. This way, COMSOL Multiphysics will generate a second solver branch.

Solution 1 (sol1)

- 1 In the **Model Builder** window, expand the **Study 1 > Solver Configurations** node.
- 2 Right-click **Solution 1 (sol1)** and choose **Disable**.
- 3 In the **Model Builder** window, click **Study 1**.

- 4 In the **Settings** window for **Study**, locate the **Study Settings** section.
- 5 Clear the **Generate default plots** checkbox.
- 6 In the **Study** toolbar, click  **Compute**.

RESULTS

Study 1/Solution 2 (sol2)

In the **Model Builder** window, under **Results** > **Datasets** click **Study 1/Solution 2 (sol2)**.

Selection

- 1 In the **Results** toolbar, click  **Attributes** and choose **Selection**.
- 2 In the **Settings** window for **Selection**, locate the **Geometric Entity Selection** section.
- 3 From the **Geometric entity level** list, choose **Boundary**.
- 4 From the **Selection** list, choose **Plate Boundaries**.

The resistive heating variable is now available on the surface of the plate. You can add a surface plot for the surface resistive heating.

Surface Loss Density, Electric

- 1 In the **Results** toolbar, click  **3D Plot Group**.
- 2 In the **Settings** window for **3D Plot Group**, type Surface Loss Density, Electric in the **Label** text field.
- 3 Locate the **Data** section. From the **Dataset** list, choose **Study 1/Solution 2 (sol2)**.

Surface 1

- 1 Right-click **Surface Loss Density, Electric** and choose **Surface**.
- 2 In the **Settings** window for **Surface**, click **Replace Expression** in the upper-right corner of the **Expression** section. From the menu, choose **Component 1 (comp1)** > **Magnetic Fields** > **Heating and losses** > **mf.Qsrh - Surface loss density, electric - W/m²**.
- 3 Locate the **Coloring and Style** section. From the **Color table** list, choose **HeatCamera**.
- 4 In the **Surface Loss Density, Electric** toolbar, click  **Plot**.

Surface Integration 2

- 1 In the **Results** toolbar, click  **More Derived Values** and choose **Integration** > **Surface Integration**.
- 2 In the **Settings** window for **Surface Integration**, locate the **Data** section.
- 3 From the **Dataset** list, choose **Study 1/Solution 2 (sol2)**.
- 4 Locate the **Selection** section. From the **Selection** list, choose **Plate Boundaries**.

5 Click **Replace Expression** in the upper-right corner of the **Expressions** section. From the menu, choose **Component I (comp1) > Magnetic Fields > Heating and losses > mf.Qsrh - Surface loss density, electric - W/m²**.

6 Click  **Evaluate**.

The result should be close to 27 W.

