

# Advanced modeling of friction stir welding – improved material model for aluminum alloys and modeling of different materials with different properties by using the level set method

Stephan M. Dörfler<sup>1</sup>

<sup>1</sup>Wilhelm Gronbach GmbH

\*Corresponding author: Burgfrieden 2, 83512 Wasserburg a. Inn, Germany, stephan.doerfler@gronbach.de

**Abstract:** Friction Stir Welding (FSW) has gained much importance throughout the last years. Beside comprehensive experimental work that has been carried out, the simulation of the welding zone is of major interest. A great number of publications on FSW FEM models have been published up to now, using the Lagrangian (ALE) as well as the Eulerian (CFD) approach. Due to the high strains observed within the welding zone, the latter approach seems to be the most promising for the prediction of flow around the FSW tool. However, the CFD modeling of FSW still faces some problems. On two of them, this paper tries to give an answer. Concerning material properties at elevated temperatures, an empirical material model is introduced based on comprehensive experimental results of torsion experiments found in literature. With that it becomes possible to model most of the common aluminum alloys in a quite precise way. The material model comprises strain rate and temperature dependency. To model the welding of different materials, the use of level set method will be introduced to friction stir welding. With that it becomes possible to predict material mixing within the weld seam.

**Keywords:** Friction Stir Welding, Aluminum, Aluminum Foam Sandwich, AFS, Material Model, Level Set Method

## 1. Introduction

Despite the fact, that friction stir welding is only known for about 17 year, a lot of research work has been published on various aspects of this joining technology. The process principle can be seen in Figure 1. A first overview over FSW Technology is given e.g. by Kallee [1].

Besides comprehensive practical research work, that has been carried out, the simulation and modeling of the friction stir welding process tries to give explanations for the complex process behavior due to the complex interactions

of temperature, material properties, external forces and material interactions.

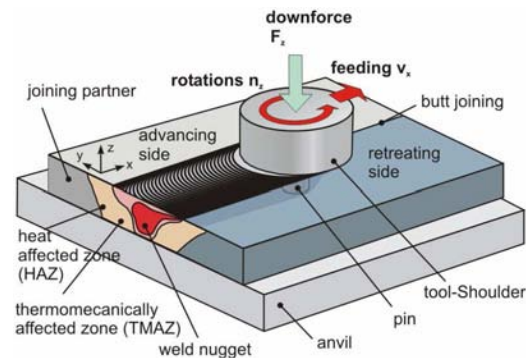

**Figure 1.** The friction stir welding process in schematic view.

However, who tries to model the friction stir welding process has to face some major problems, like really high strain rates significantly greater than one [2]. Therefore one of the most promising approaches to model the material flow throughout the joining zone is the Eulerian approach used in fluid dynamics (in the following referred as CFD).

With the use of CFD models it is quite difficult to approximate metal material behavior accurately, due to the yielding characteristic of the material behavior. This even gets worse due to the fact, that only poor data on flow behavior at elevated temperatures and high strain rates is available. Most FSW models therefore make use of common material models such as Johnson-Cook, sometimes together with some adoptions for high temperatures near solidus temperature [3, 4]. This approach leads to rather good results for some aspects. However, with increasing complexity and quality of the models, the wish for better material models becomes stronger.

Another limitation of existing models is the missing possibility to implement the welding of different materials with different properties. Material mixing within the welding zone

therefore has to be discussed by streamlines for the case of welding homogeneous material. But just the welding of different alloys or metals is of major interest due to the fact that certain properties of the weld seam depend on the local distribution of the welded materials. These limitations shall be overcome in the following by introducing an advanced FSW-model.

## 2. Material Modelling

The logarithmic strains observed and predicted during friction stir welding are of reasonably high values significantly over 1 (e.g. see [5]). Therefore tensile testing results are suitable only to a limited extent. To model the material behavior more precisely, comprehensive tensile tests being published by Akeret et. al. [6] are used, to develop a new, empirical material model. Due to the fact, that at elevated temperatures over 300 °C and high logarithmic strains over 1 the strain rate as well as temperature dependency are the main influences on yield stress, the strain rate is neglected and the following empirical model can be stated:

$$k_f(\dot{\phi}, T) = a_a + b_a \cdot T + c_a \cdot T^2 - a_b \cdot (T - b_b) \cdot \ln(\dot{\phi} + a_c + b_c \cdot T + c_c \cdot T^2)$$

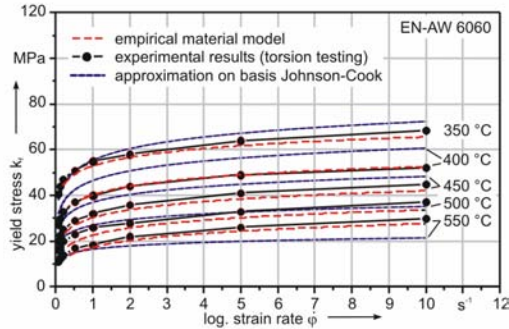

**Figure 2.** Comparison between the proposed empirical material model with experiments and the Johnson-Cook model.

The empirical model factors have been worked out for strain hardenable aluminum alloys as well as for precipitation hardenable alloys and show for both types good results. The improve the accuracy of modeled material behavior is shown in **Figure 2**, where it is compared to the

experimental results as well as a best fit for a power law approach (Johnson-Cook).

For two aluminum alloys the model factors are illustrated in Table 1:

**Table 1:** Material model factors for two different aluminum alloys.

Model factor	Unit	EN-AW 3103	EN-AW 6060
$a_a$	MPa	624,16	401,53
$b_a$	MPa·K <sup>-1</sup>	-1,4096	-0,8465
$c_a$	MPa·K <sup>-2</sup>	$8,2 \cdot 10^{-4}$	$4,6 \cdot 10^{-4}$
$a_b$	MPa·K <sup>-1</sup>	0,02872	$3,97 \cdot 10^{-3}$
$b_b$	K	958,3	2041,3
$a_c$	s <sup>-1</sup>	0,084	2,62
$b_c$	s <sup>-1</sup> ·K <sup>-1</sup>	$-6,02 \cdot 10^{-5}$	$-7,86 \cdot 10^{-5}$
$c_c$	s <sup>-1</sup> ·K <sup>-2</sup>	$1,44 \cdot 10^{-7}$	$5,971 \cdot 10^{-6}$

## 3. Model Equations

The developed FSW model is based on the well known equations for the **conservation of mass**:

$$\frac{\partial \rho}{\partial t} + \nabla \cdot (\rho \vec{u}) = 0,$$

that, assuming incompressible fluids, simplifies to:

$$\nabla \cdot (\rho \vec{u}) = 0.$$

Further the **momentum equations** are employed:

$$\rho \vec{g} + \vec{\sigma} = \rho \frac{d\vec{u}}{dt} + (\rho \vec{u} \cdot \nabla) \vec{u},$$

that can be shortened to the following equation presuming steady state material flow within the welding zone and no significant influence of gravitation on the result:

$$\frac{d\vec{u}}{dt} = 0 \Rightarrow -\nabla p + \nabla \vec{\tau}_{ij} = (\rho \vec{u} \cdot \nabla) \vec{u}.$$

While the upper equations seem no problem, with the **constitutive equation** quite a problem has to be faced, the yield stress. Perfect yielding material behavior is known as Bingham Fluid behavior and would have to be implemented by the following:

$$\text{Bingham Fluid: } \begin{cases} \vec{\tau} < \tau_0 : \dot{\gamma} = 0 \\ \vec{\tau} \geq \tau_0 : \vec{\tau} = \left( \frac{\tau_0}{\dot{\gamma}} + \eta \right) \cdot \dot{\gamma} \end{cases}$$

To cope with the problems by that, the approach of Papanastasiou [7] with the following form:

$$\bar{\tau} = \left( \frac{\tau_0(1 - e^{-m\dot{\gamma}})}{\dot{\gamma}} + \eta \right) \cdot \dot{\gamma}$$

could be used with fairly good results. However, temperature and shear rate dependency is not properly implemented by Bingham/Papanastasiou for aluminum metal flow behavior. Therefore the upper approach is modified to the following form:

$$\bar{\tau} = \left( \frac{\tau_{kf}(\dot{\gamma}, T)(1 - e^{-m\dot{\gamma}})}{\dot{\gamma}} \right) \cdot \dot{\gamma}$$

Herein the term  $\tau_{kf}$  is the empirical material model transformed to the eulerian shear stress (for transformation see i.e. [8, 9]). However, with that no convergence could be achieved due to the fact that for very low values of the exponent of  $e$  turns zero and the shear stress tensor as well.

To avoid this, a own parameter is introduced and named as convergence parameter  $m$  to accentuate its function:

$$\bar{\tau} = \left( \frac{\tau_{kf}(\dot{\gamma}, T)^m}{(\dot{\gamma} + h)^m} \right) \cdot \dot{\gamma}$$

The convergence parameter  $m$  is chosen as exponent in a way, that the highly nonlinear term becomes eliminated for  $m = 0$  and is fully effective for a value of  $m = 1$ . The constant  $h$  is used to achieve convergence when the shear rate is zero and is chosen very small so that it doesn't affect accuracy of the model. The parameter  $m$  is increased from zero to one during the calculation using the parametric solver provided with Comsol software. With that the solution of the yielding aluminum material behavior is converged, beginning with an ideal viscous fluid. Temperature is modeled due to the well known equations. The basis for temperature modeling are experimental measurements of temperature within the welding zone.

To implement the different material properties, the level set method is employed. For an introduction to level set method see i.e. [10]. The level set allows coupling of a virtual concentration to the material flow. The sign of  $c$  describes, which of the both joined materials is present at a local point of the domain. With that the different flow stress can be implemented as a function of  $c$ :

$$k_f = k_{fA} + \frac{1}{2}(1 + \text{sign}(c')) \cdot (k_{fB} - k_{fA})$$

This allows to track the interface all over the model domain and to include different material properties in the constitutive equation.

### 3. Boundary conditions

The material flow is prescribed to constant speed at the bottom, sides and inflow of the model domain. The frictional condition between tool and material interface is assumed to be perfect sticking, following the scientific works of Schmidt and Hattel [2], that revealed, that shear phenomena are most relevant for the tool/material interface.

The concentration  $c$  from the level set method is limited at the inflow surface to a linear function. Its zero that shapes a line coincidences with the butt joint of the two materials

$$c'_{Inlet}(y, z) = a \cdot (y - \Delta y),$$

where  $\Delta y$  is the lateral displacement of the weld centerline in relation to the butt joint.

The tool design and process parameters used for the model are chosen similar to experimental setup carried out at LFT, Erlangen, Germany [11]. The tool pin has a diameter of 3.4 mm and a length of about 3.3 mm with a conical tip. The tool shoulder has a diameter of 13 mm. Thickness of the joint sheet metal is 3.4 mm. The rotational speed is varied in a range of 100 to 2000 rpm and the welding speed is 0.4 m/s. For further details, refer to [11].

### 4. Implementation

The model was implemented using the chemical engineering module of Comsol 3.4 together with a quad-core á 2.4 GHz computer with 8 GB memory. The model in total has about 200,000 degrees of freedom. Processing the full model requires about 38 hours. The model mesh can be seen in Figure 3.

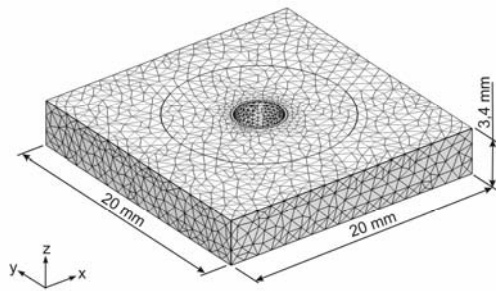

**Figure 3.** Model domain and model mesh used for calculations. Tool pin has a cylindrical shape, while the tool-shoulder is shown as the circle-line on top of the domain.

### 5. Results

Before analyzing the welding process itself, it shall be shown, how convergence can be achieved by the modification of the convergence parameter  $m$ . The convergence parameter  $m$  is needed due to the fact, that a direct approach does not converge. This is, because for directly implementing the yielding behavior it would be necessary, to know, at which locations yield stress is exceeded (regions with plastic deformation) and where local stresses are lower than yield stress (simple material transport without plastic deformation). By using  $m$  the described discontinuity can be overcome in the following way:

When  $m$  is zero, the constitutive law equals a simple, Newtonian fluid. According to this, the velocity field within the domain shows wide deflections of the fluid around the tool that only is limited through the boundaries (Figure 4). For increasing values of  $m$  the deflection of the streamlines is reduced and finally with  $m = 1$  it shows the real material behavior.

With the convergence parameter  $m$  it becomes possible, to calculate the multiphysic model under full convergence and get realistic material distributions for the welding of different materials. In Figure 5 the interface of a butt joint configuration is shown, joining EN-AW 6060 with EN-AW 3103 aluminum alloy.

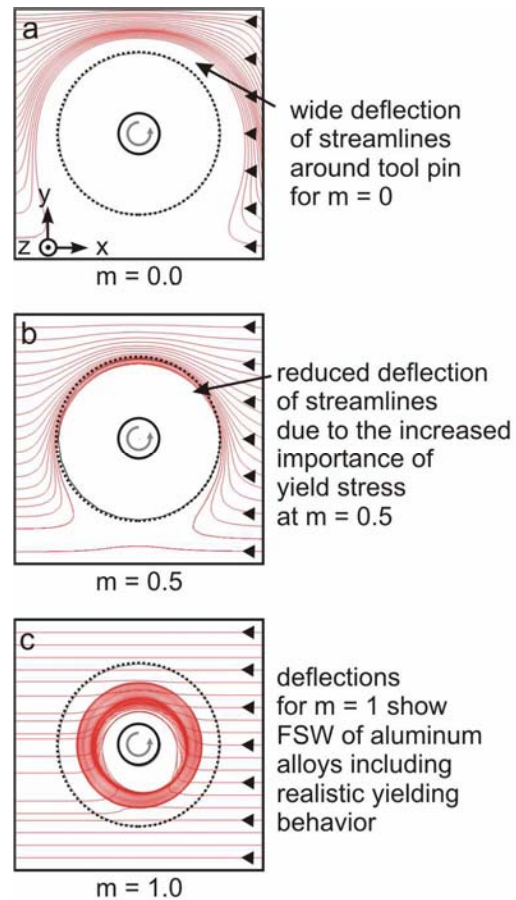

**Figure 4.** Showing the significance of the convergence parameter  $m$  with streamlines (released at the inlet at  $z = -1,7$  mm).

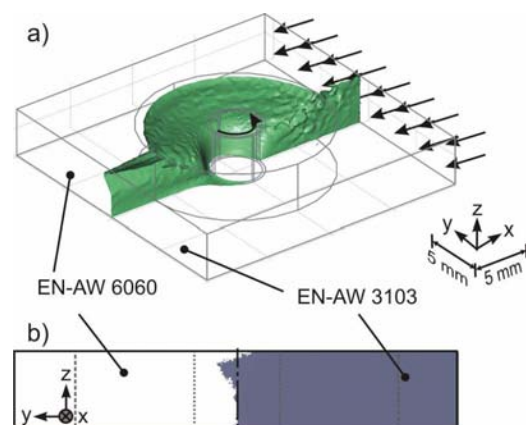
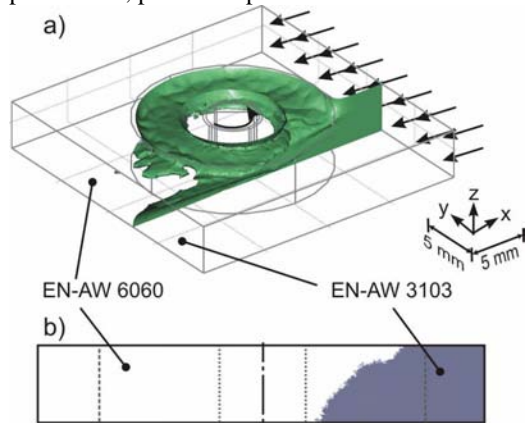

**Figure 5.** Modification of the interface within the weld zone when welding two different aluminum alloys ( $\Delta y = 0$  mm).

In Figure 5a it can be clearly seen, how the former plain interface is deflected by the tool movement towards the retreating side. On the backside of the tool, the interface is deposited in a deformed shape (Figure 5b), characteristic for the welding of these two different materials.

In another configuration, the lateral displacement is chosen in a way so that the interface gets cut by the tool pin. This is the case, when  $\Delta y$  is about 2.5 mm. Due to the specific material flow, the upper part of the interface gets deflected and is transported through the retreating side and meanwhile the lower part of the interface runs over the advancing side (see Figure 6a). The resulting geometry of the interface differs significantly from the above shown example (see Figure 6b).

This shows, that with the proposed model various phenomena of friction stir welding now can be explained more precisely. The allocation of the different joining partners becomes predictable, prior to experiment.



**Figure 6.** Modification of the interface within the weld zone when welding two different aluminum alloys ( $\Delta y = -2.5$  mm).

The prediction of interfaces between different joining partners by the numerical model of this paper is new and gives some extra tools for process design and tool lay out. Besides that, all the formerly published methods for analyzing CFD-FSW models can be used for the proposed model as well. The difference is that with the implementation of different material properties the significance of the results is increased.

During friction stir welding material gets also deflected in welding direction due to the different speed along streamlines. To show this, particle tracer technique was used in Comsol and are compared with practical experiments. As can be seen in Figure 7. On the retreating side, material gets pushed in opposite welding direction and particles that run through the plasticized zone are allocated in form of a bow. On the division between the material that was transported over the retreating and advancing side, the tracer particles show a discontinuity together with a significant deflection of the particles in welding direction. The tracer particle positions agree well with experiments in which copper foil has been used to mark the deflections by the welding process.

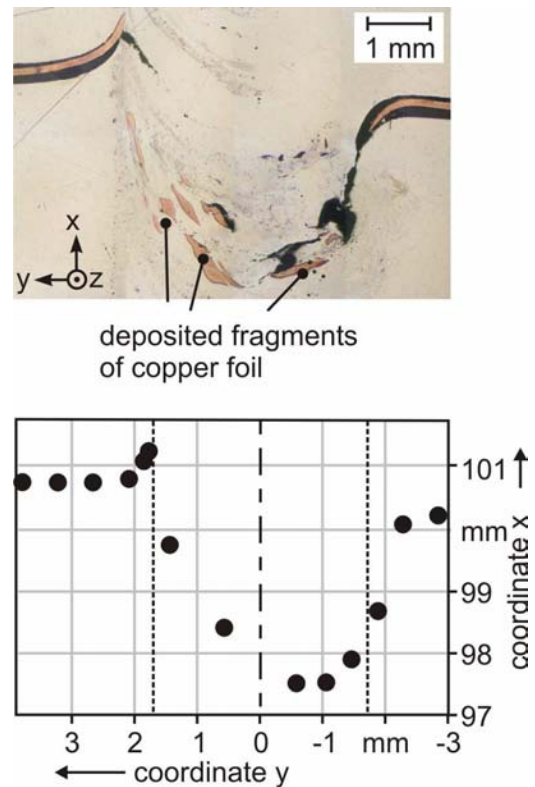

**Figure 7.** Deflection of copper fragments (experiments) and tracer particles (simulation) due to the welding process.

## 6. Excursus - coextrusion of aluminum alloys

The proposed model can easily be transferred to other forming processes that form aluminum alloys under relatively high temperatures and high strains. As one example, coextrusion of different aluminium alloys should be mentioned shortly. Aluminum extrusion is a well known process. For coextrusion a extrusion ingot composed of two metals is used, with a core out of EN-AW 3103 and an outer ring out of EN-AW 6060. This for example would allow to combine good electric conductivity of the core together with excellent anodizing properties of the shell. The ingot is pressed through a quadratic tool forming a rectangular, massive extrusion profile.

The used process parameters are typically for aluminium extrusion. The used boundary conditions are based on literature ([12, 13]).

As can be seen in Figure 8, the resulting material distribution of the produced profile can be predicted. With that the material flow through the forming zone can be tracked not only with streamlines, but also by the virtual concentration  $c$ . Even though this is quite a simple example, it can be seen, that the resulting material distribution within the profile cross-section is not trivial. More complex geometries are to be simulated and will even more show the effectiveness of the proposed model. The tooling for coextrusion will be simplified by the use of the model, as the number of practical extrusion tools can be reduced significantly.

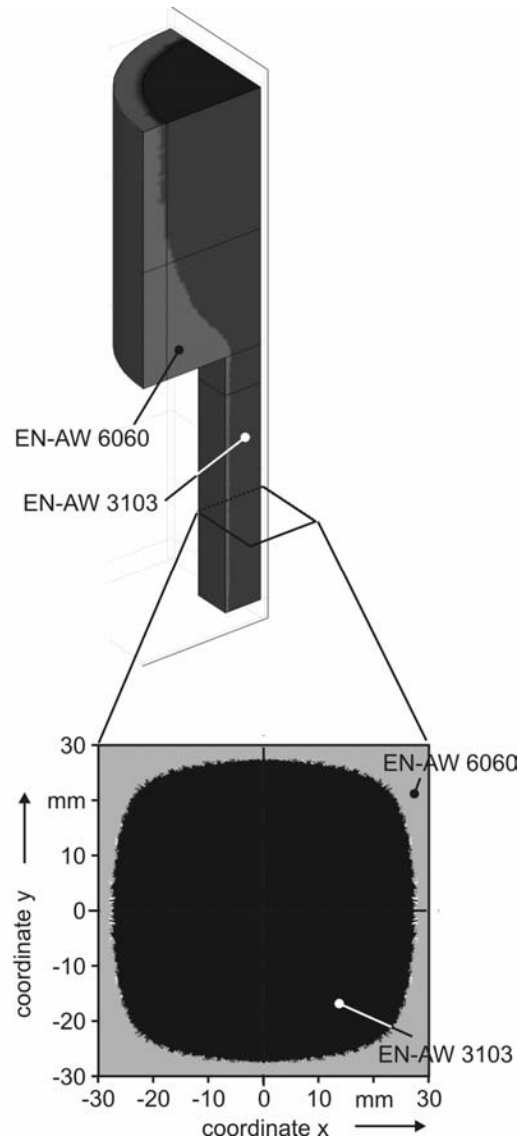

**Figure 8.** Simulation of coextrusion using the introduced material model and the FSW-model equations.

## 7. Conclusions

This paper introduces an advanced CFD model for the simulation of friction stir welding of different aluminum alloys. To achieve precise results on material distribution, a improved, empirical material model is introduced that well suits aluminum alloys. This material model is based on torsion tests and is indicated for forming processes under temperatures above 300 °C and high plastic strains.

Furthermore the level set method is used for the first time together with friction stir welding to implement different material properties. With that, the prediction of material distribution within the weld seam becomes possible.

With these amendments to the state of the art in modeling, some problems have to be faced to achieve convergence. Therefore a special technique is shown to achieve convergence on highly nonlinear problems by introducing a convergence parameter  $m$  and using the parametric solver provided by Comsol software. The convergence parameter  $m$  is subsequently increased and the initial conditions of the subsequent calculation are based on the solution of the preceding calculation.

The presented work with its modified equations not only allows improving modeling of friction stir welding, but also is suitable for other forming processes. As one example the coextrusion of two different aluminum alloys is shown.

The author of this paper hopes to give some new impulses to the modeling of FSW. With the implementation of the level set method to FSW, the target-orientated optimization of tool geometry becomes possible. The weldability of different materials now can be analyzed and understood more profoundly. In addition to that, the empirical material model gives some good data basis for the CFD modeling of aluminum that should also be interesting for many other processes with high strains at elevated temperatures.

## 8. References

- [1] Kallee, S.W.; Nicholas, E.D.; Thomas, W.M.: *Reibrihrschweißen: Erfindung, Innovationen und Industrialisierung - Friction Stir Welding: Invention, Innovations and Industrialisation*. In: *Seminar Rührreibschweißen (FSW) - ein modernes Fügeverfahren*. Schweißtechnische Lehr- und Versuchsanstalt (SLV) Berlin-Brandenburg, Berlin, 2002
- [2] Schmidt, H.; Hattel, J.; Wert, J.: *An analytical model for the heat generation in friction stir welding*. Modelling and Simulation in Materials Science and Engineering, 12(2004)1, S. 143-157
- [3] Colegrove, P. A.; Shercliff, H. R.: *Two-dimensional CFD modelling of flow round profiled FSW tooling*. Journal of Science and Technology of Welding and Joining, 9(2004)6, S. 483-492
- [4] Colegrove, P. A.; Shercliff, H. R.: *Modelling the Friction Stir Welding of Aerospace Alloys*. In: *Proceedings of the 5th International Symposium on Friction Stir Welding*. TWI, Metz, Frankreich, 2004
- [5] Schmidt, H.; Hattel, J.: *A local model for the thermomechanical conditions in friction stir welding*. Modelling and Simulation in Materials Science and Engineering, 13(2005)1, S. 77-93
- [6] N.N.: *Band 1 - Aluminiumwerkstoffe*. Hrsg.: Akeret, R.; Jung, H.; Scharf, G.: *Atlas der Warmformgebungseigenschaften von Nichteisenmetallen*. Oberursel: Deutsche Gesellschaft für Metallkunde, 1978
- [7] Papanastasiou, T.C.: *Flows of materials with yield*. Journals on Rheology, 31(1987)87, S. 385-390
- [8] Döll, S.: *Zur numerischen Behandlung großer elasto-viskoplastischer Deformationen bei isochor-volumetrisch entkoppeltem Stoffverhalten*. Karlsruhe: Universität, 1998
- [9] Lippmann, H.: *Mechanik des plastischen Fließens*. Berlin, Heidelberg, New York: Springer-Verlag, 1981
- [10] Osher, S.; Sethian, J.A.: *Fronts Propagating with Curvature-Dependent Speed: Algorithms Based on Hamilton--Jacobi Formulations*. Journal of Computational Physics, 79(1988), S. 12-49
- [11] Dörfler, S.; Otto, A.: *Friction Stir Welding of Light Weight Sandwich Materials*. In: *Proceedings of the 11th International Conference on Sheet Metal*. Transtech Publications, Zürich, Schweiz, 2005, S. 607-612
- [12] Bauser, M.; Sauer, G.; Siebert, K.: *Stangpressen*. Düsseldorf: Aluminium-Verlag, 2001
- [13] Schikorra, M.: *Modellierung und simulationsgestützte Analyse des Verbundstrangpressens*. Aachen: Shaker-Verlag, 2006

## 9. Acknowledgements

The referred practical experiments have been carried out during my time at LFT, for which I'd like to thank Prof. Geiger, Prof. Merklein and Dr. Otto. Furthermore I'd like to thank Wilfried Gronbach (Gronbach GmbH) and Dr. Fluche (Comsol Multiphysics) for their appreciation of my work.