



COMSOL V4

The Desktop

Model Builder

Tree node settings

Graphics

Messages

The screenshot displays the COMSOL Multiphysics desktop environment. The interface is divided into several key areas:

- Model Builder:** Located on the left, it shows a hierarchical tree of the model's structure, including Definitions, Geometry, Materials, Physics, Meshes, and Results.
- Tree node settings:** The central panel shows the settings for the selected 'Material' node, specifically for 'Copper'. It includes fields for Name, Tag, and Comments, as well as a Geometric Scope section.
- Material Property Browser:** This section displays the material's properties, categorized into 'Material Property Browser', 'Material Status', and 'Material Contents'. It includes a table of properties used by physics interfaces and a table of properties not used.
- Graphics:** The right side of the interface features a 3D visualization of the planar transformer model, rendered with a color gradient from blue to red to represent different physical quantities.
- Messages:** At the bottom, a progress bar indicates the status of the simulation, showing 'Finished' and a 'Progress Convergence Parameter Value'.

Property	Name	Value	Unit	Prop.
Density	rho	8700	kg/m ³	
Thermal expan... coefficient	alpha	17e-6	1/K	
Heat capaci...nt pressure	cp	385	J/(kg*K)	
Relative permeability	mur	1	1	
Electric conductivity	sigma	5.998e7	S/m	

The Four Main Branch Types

- Definitions
- Model
- Study
- Results

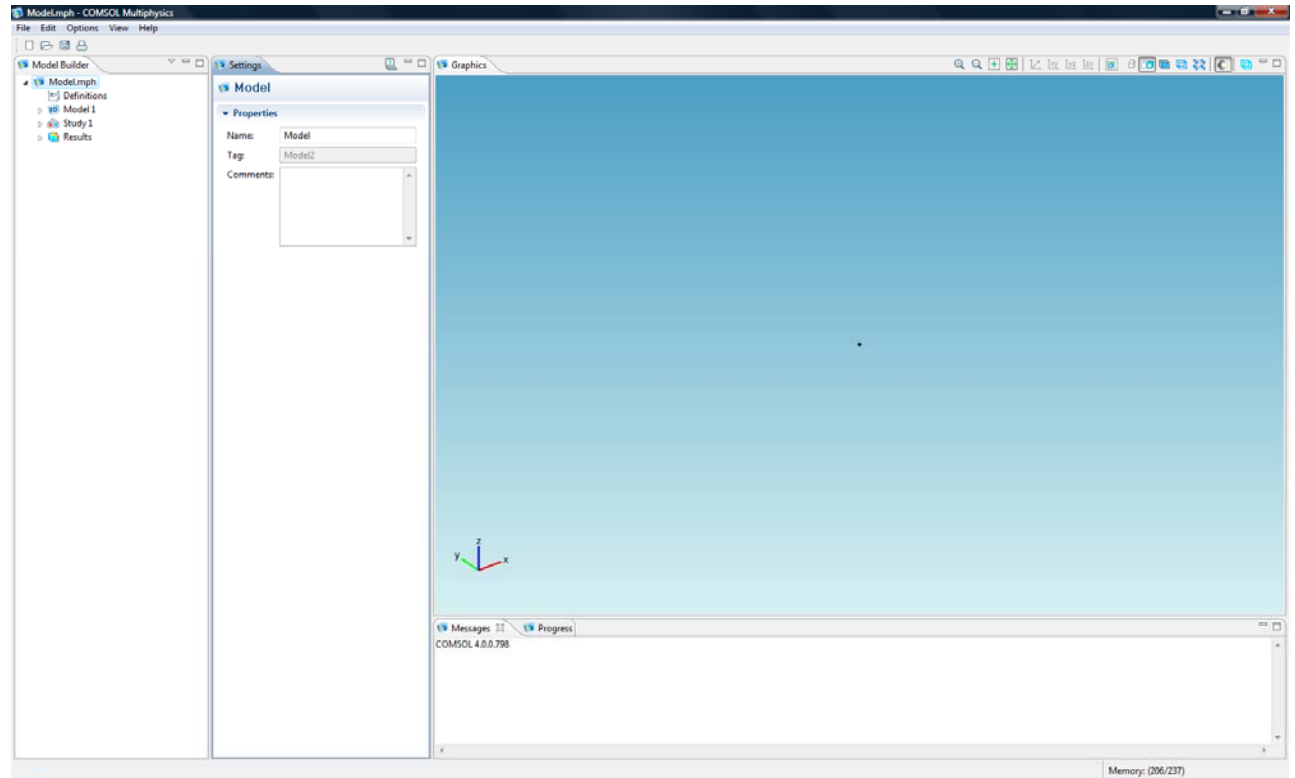

Sequence of Operations

Tree nodes define sequences of operations

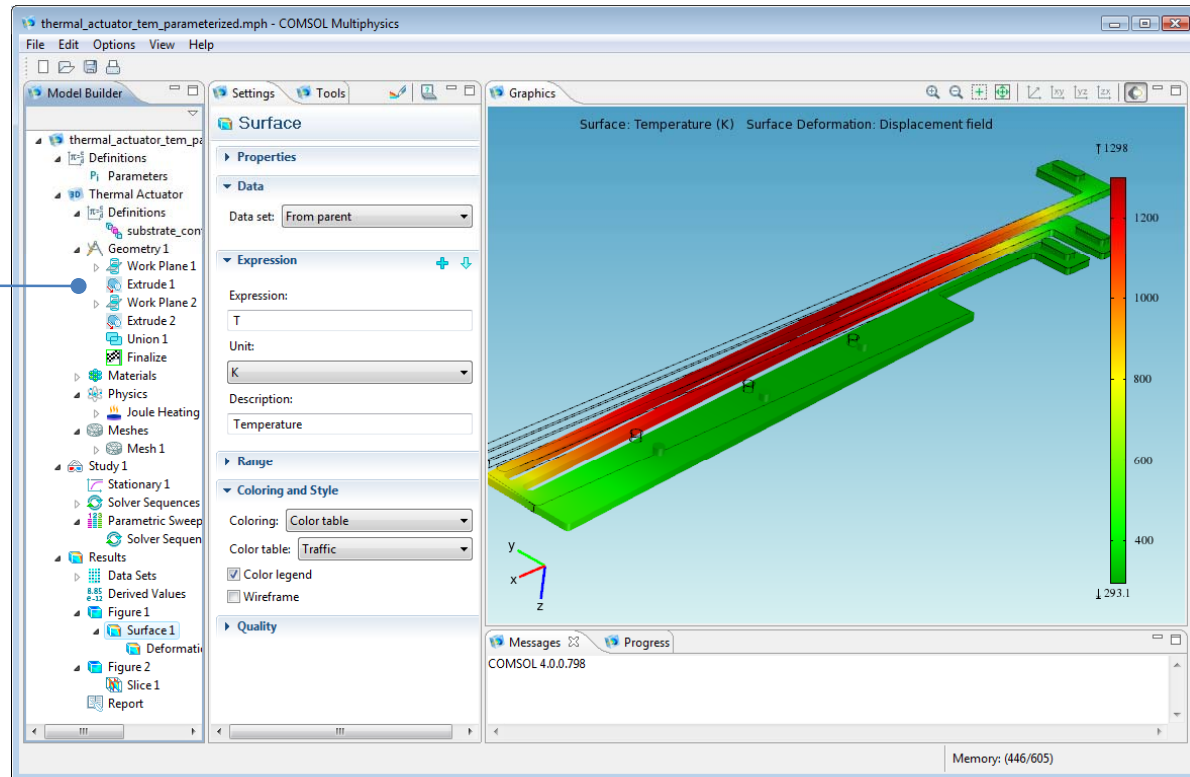

Geometry Sequence and Parametric Sweeps

The geometric sequence allows you to run geometry parameter sweeps with full associativity

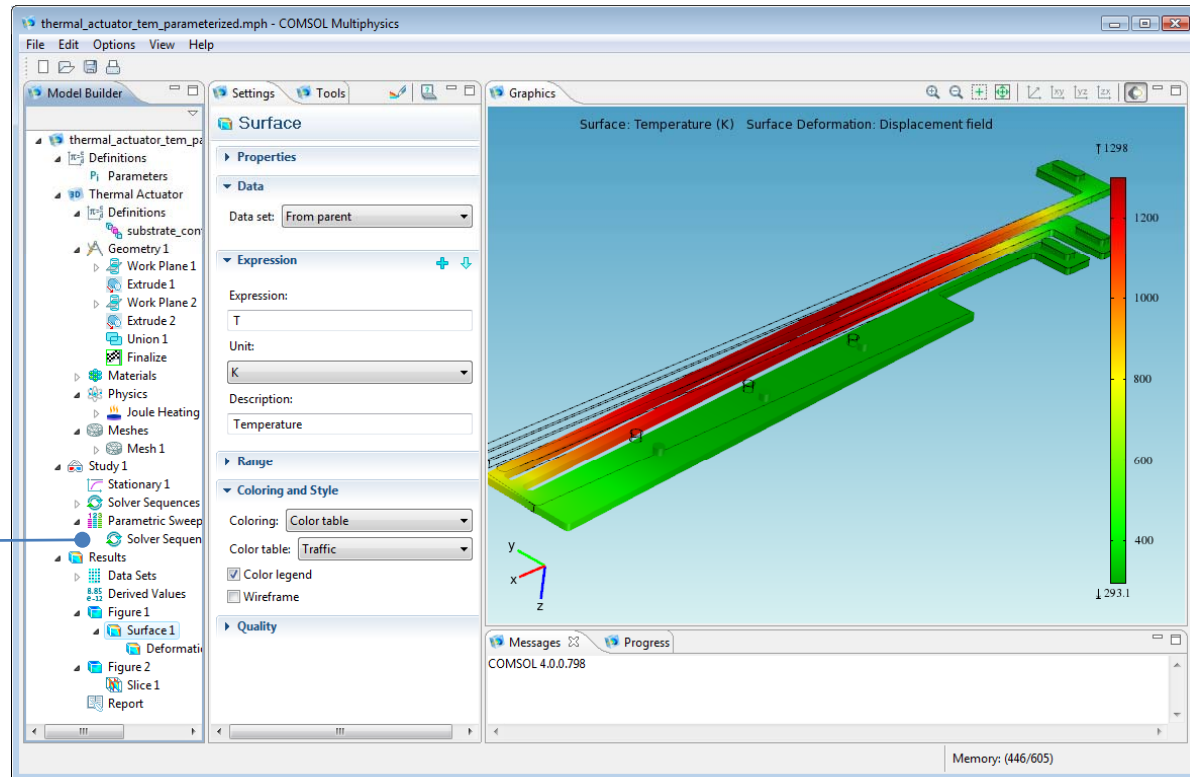

Management of Materials

Add material to the tree, and set the properties.

The Material Settings window lists materials:

- Defined and used
- Defined and unused
- Needed but undefined

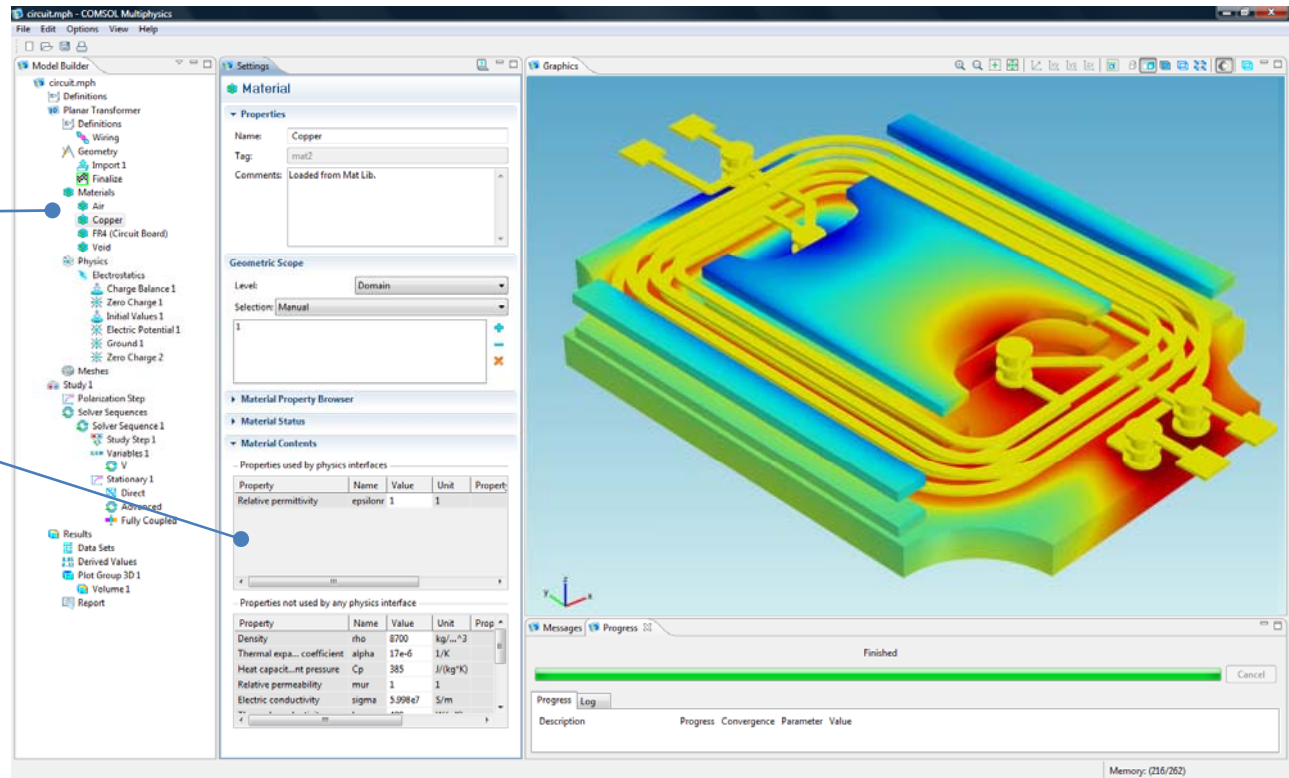

Physics Interfaces

Add Physics to the model by selecting from the list of predefined physics interfaces or build your own by defining a PDE.

Add boundary conditions, sources, sinks, loads, constraints, etc. as needed.

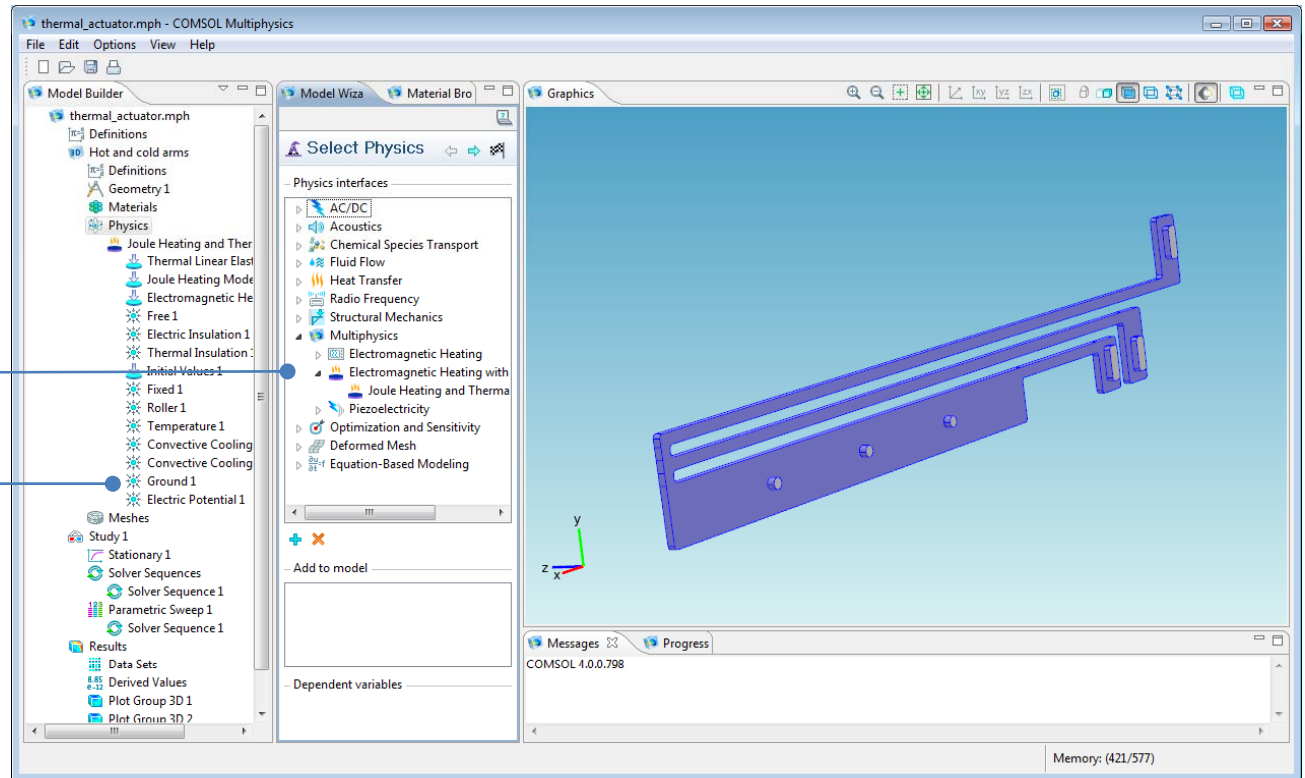

The Study

Set up studies:

- Analysis types
- Solver sequences
- Parametric sweeps
- Cluster computing

Analyze, visualize, and compare several solutions

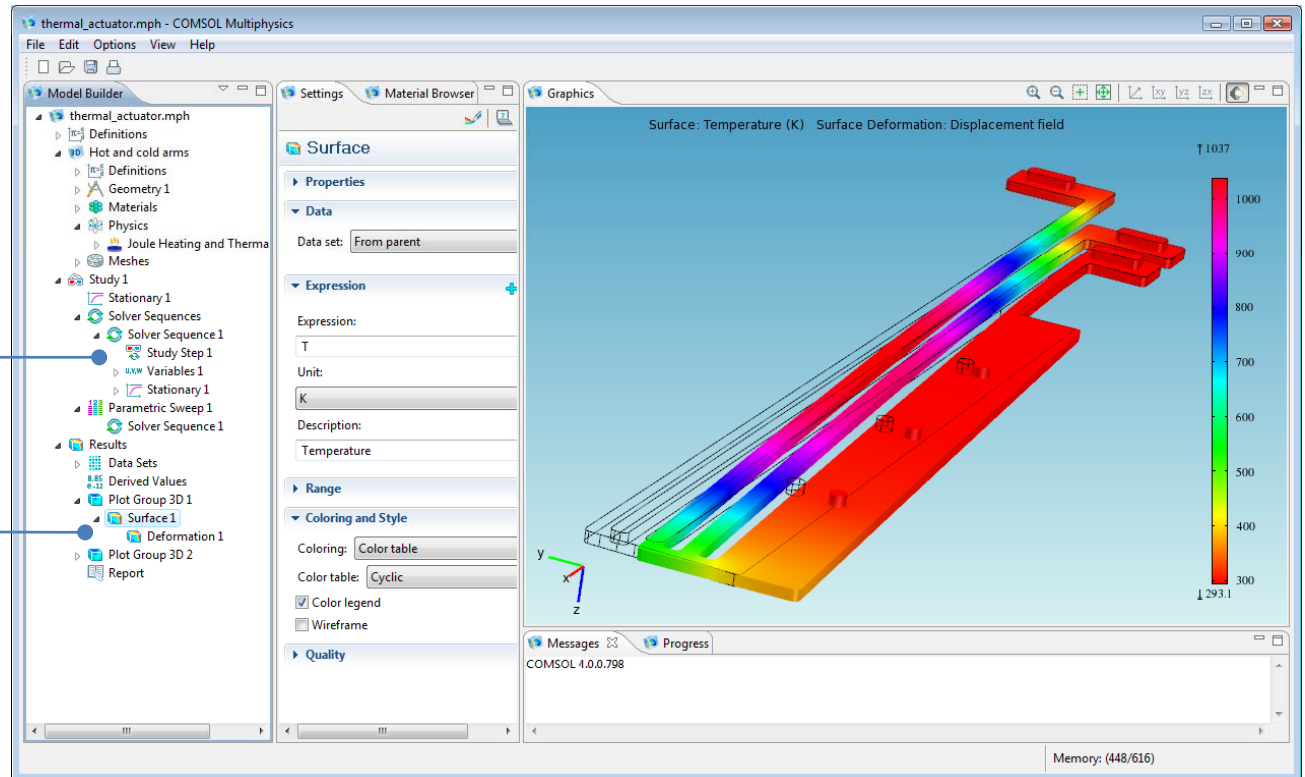

Dynamic Help

Context dependent help makes it easy to browse and search

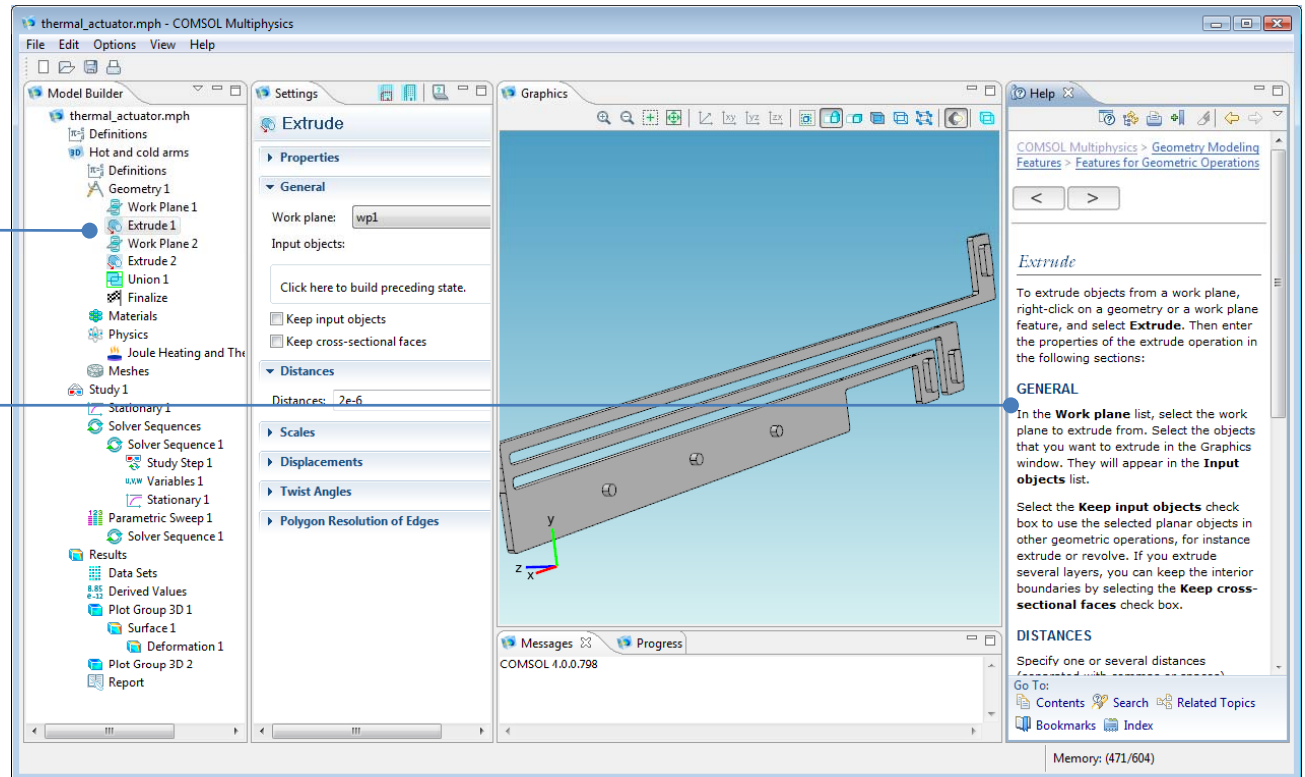

New Geometry Functionality

- Geometry parameter sweeps with full associativity
- The Parasolid kernel replaces the COMSOL kernel when the CAD Import Module is installed; 3D geometry operations can be applied to imported geometries.
 - This makes it the possible to manually repair imported CAD geometries
- LiveLinks™ for CAD Systems:
 - LiveLink for SolidWorks®
 - LiveLink for Inventor®
 - LiveLink for Pro/E®

More Physics Interfaces

- Additional Physics Interfaces
- Additional Predefined Multiphysics Interfaces

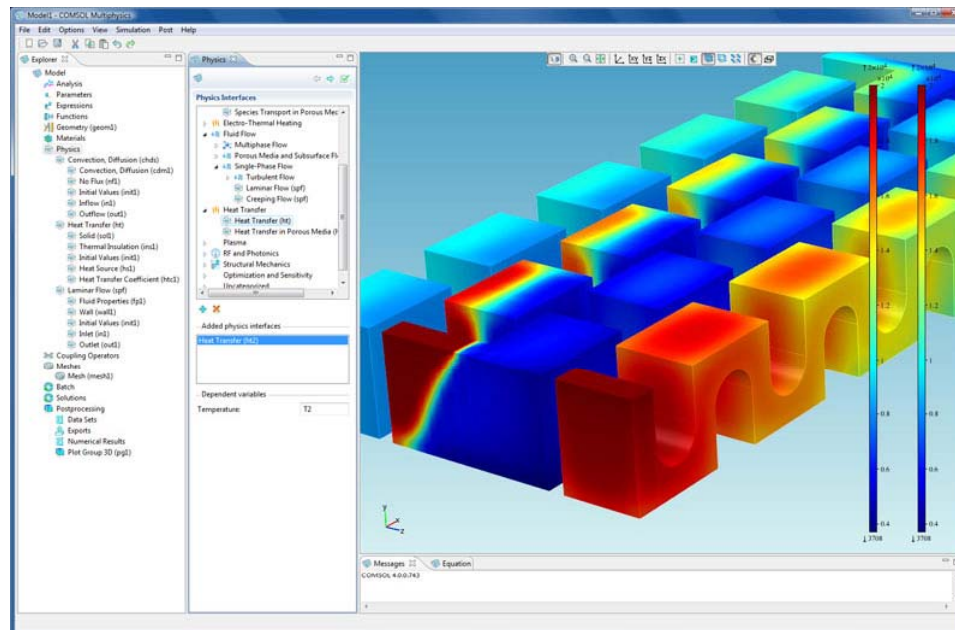

New Solvers

- MUMPS and SPOOLES for cluster computing
- Modal solver for frequency response and time domain (for structural and acoustics simulations for example).
- AWE solver for harmonical electromagnetics simulations
- Predefined analysis combination: non-linear + frequency-response solver (for small signal analysis and pre-stressed structures simulations for example)
- Non-linear least squares solver for parameter estimation

A Database Aspect

Each node in the tree is a database record.

Data such as author, create date, comments, etc. can be stored with each node.

Nodes with or without subnodes can be saved separately to disk and become parts of user libraries.

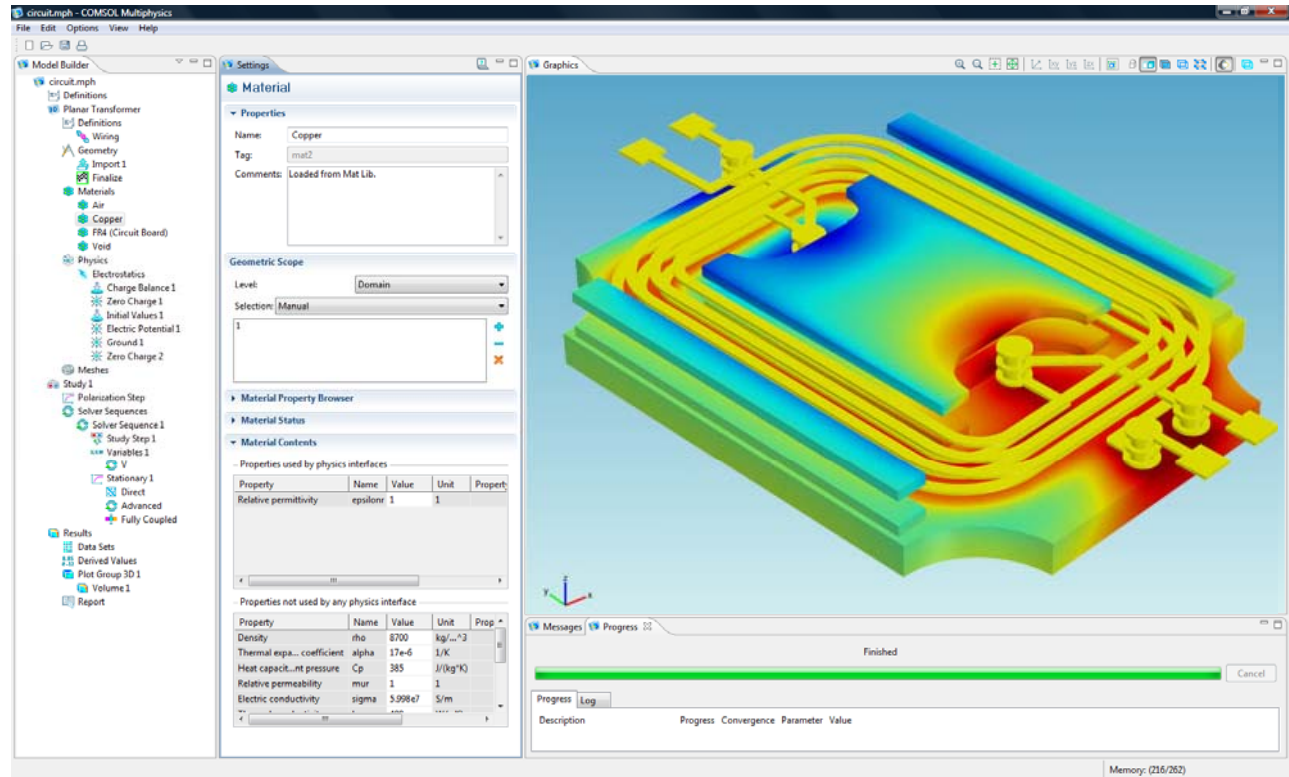

The Upcoming CFD Module

- Traditional CFD
 - Efficient computation of traditional fluid flow problems
- Multiphysics
 - Fluid flow with arbitrary physics combinations
- The CFD Module combines the best qualities of dedicated CFD packages with the Multiphysics capabilities of COMSOL

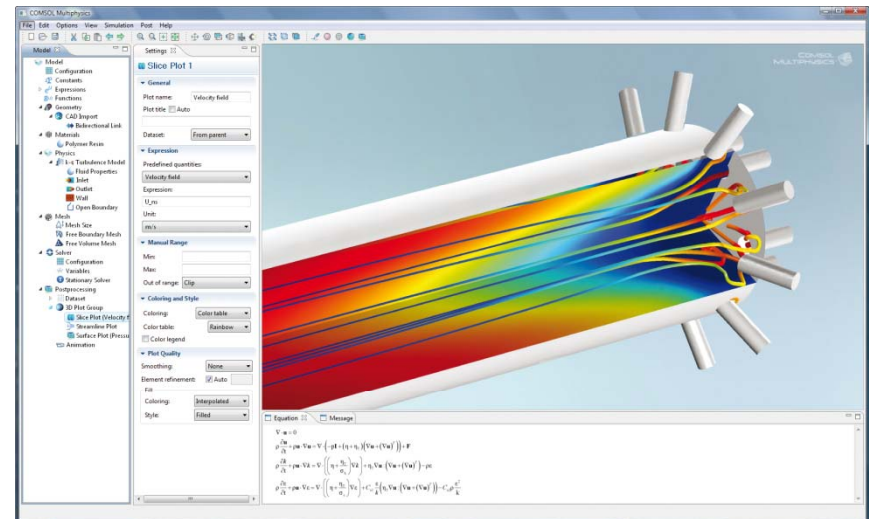

Capabilities in the CFD Module

- Interface for rotating machinery
 - Laminar and turbulent models
- Turbulent flow
 - k - ε turbulence model, including low Re
 - k - ω turbulence model, including low Re
 - Spalart-Allmaras I-Eq model
 - SST turbulence model*
 - Large Eddy Simulations*
- Compressible flow
 - Compressible Navier-Stokes
 - Compressible Euler*

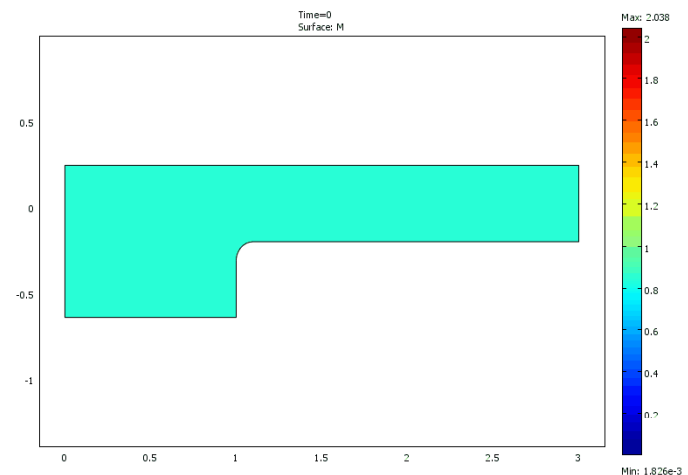
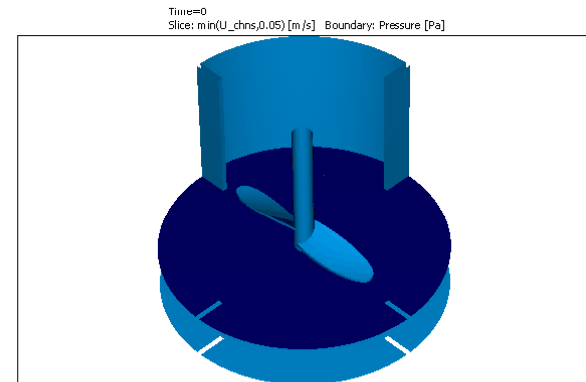

* Not in first version

Capabilities in the CFD Module

- **Viscoelastic flow**
 - User interfaces for generalized Maxwell models and Oldroyd-B models
- **Multiphase flow**
 - Extended with the Euler-Euler model for heavy particles in fluids
- **Porous media flow**
 - Coupled turbulent flow and porous media flow
- **Pipe-flow / Bernoulli-flow**
 - Automatic laminar-turbulent friction factor calculations
 - Surface roughness for turbulent flows
- **Laminar flow**
 - Shell Navier-Stokes for flow in thin layers (applications in lubrication, earth science, fractured media)

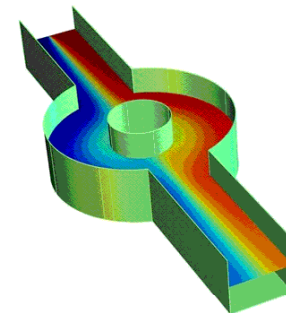
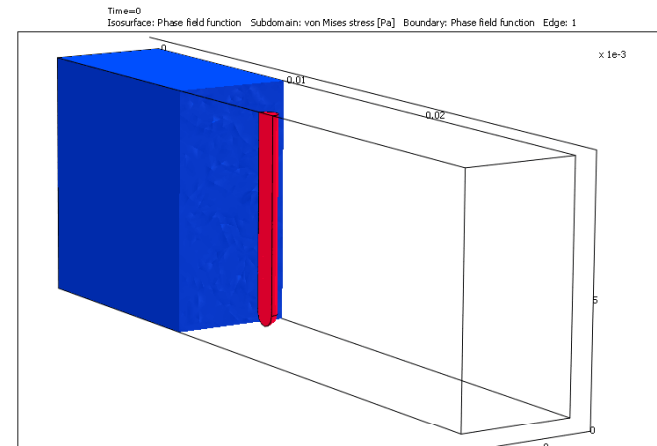

Solver Capabilities in the CFD Module

- Cluster computing
 - Performance
- Discontinuous Galerkin
 - First Order: Accuracy, performance
- Fully segregated solver for flow equations
 - Performance (memory)
- Improved meshing (boundary layer mesh, mesh control in domain interior)
 - Accuracy, usability
- Numerical stabilization
 - Performance, robustness

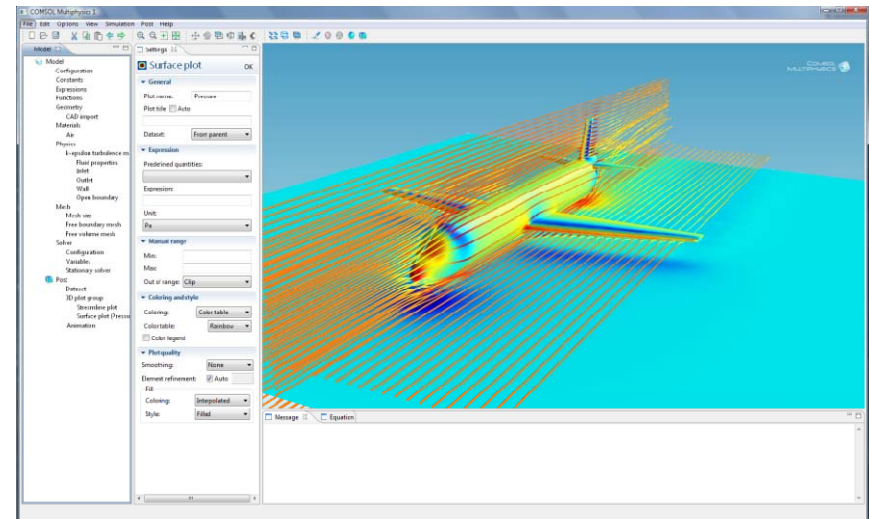

Fluid dynamics simulations require cluster computing for reasonable computational time

The Batteries & Fuel Cells Module

- Specialized tool:
 - Models and simulates all types of battery and fuel cell applications
 - First of its kind on market
- Tailored functionality/interfaces for:
 - Primary, secondary and tertiary current density distribution
 - Porous and gas diffusion electrodes
 - Dilute and concentrated electrolytes
- Multiphysics
 - Flow, electromagnetics and heat transfer with electrochemical reactions

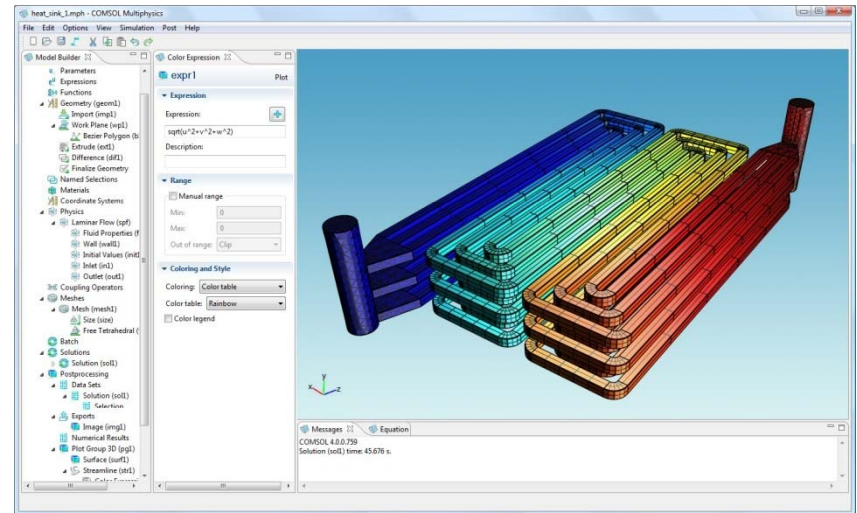

Applications Covered

- Batteries
- Fuel Cells

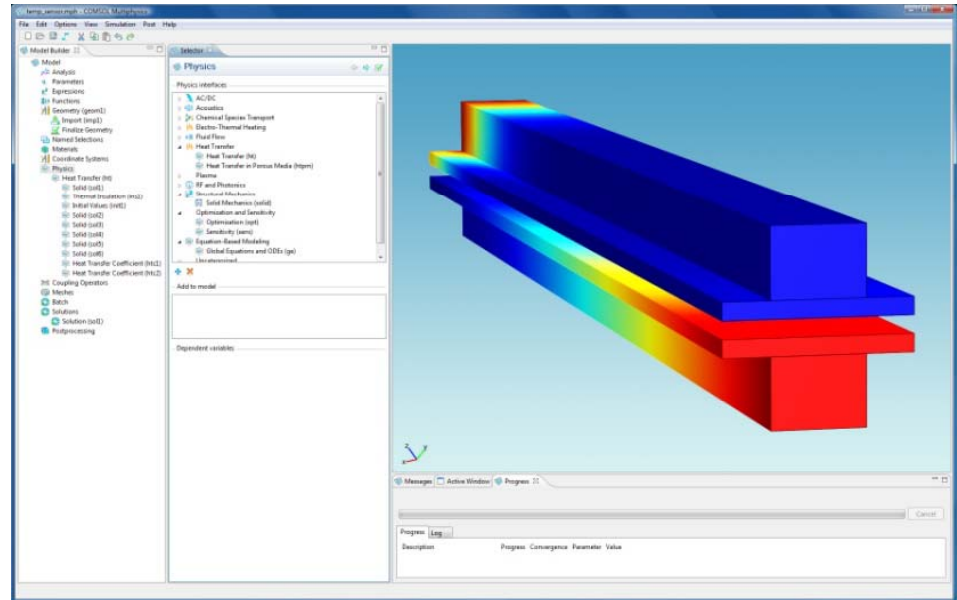

Concentration Distribution in a Solid Oxide Fuel Cell

Supporting Capabilities in COMSOL Multiphysics®

- Fluid Flow capabilities
- Material Properties
- Other Physics
- CAD capabilities

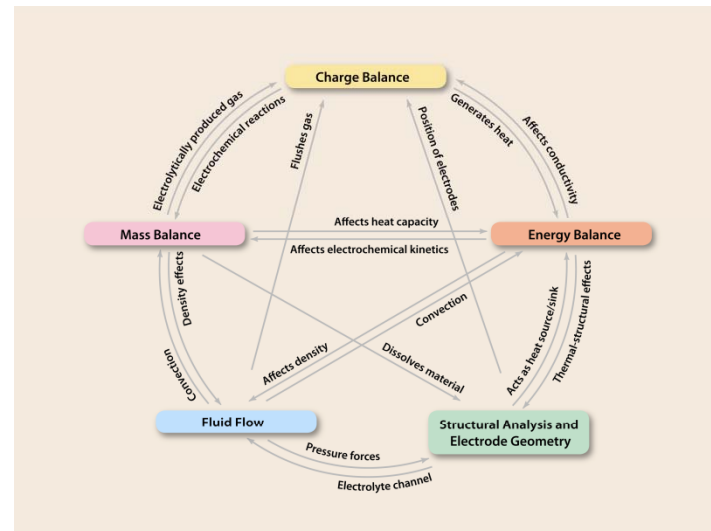

Multiphysics involved in the electrochemical machining of an electric razor head

The Plasma Module

- Specialized tool to:
 - Model and simulate all types of non-nuclear plasma reactors
 - Provide a simple interface for a complicated problem
- Multiphysics:
 - Plasmas are a perfect example of a true Multiphysics problem

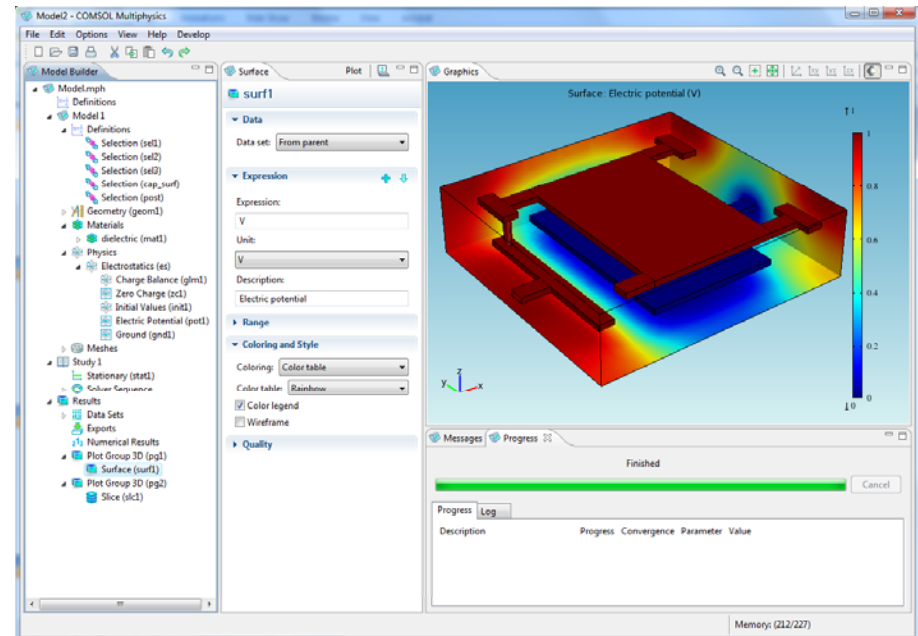

Applications Covered by the Plasma Module

- Industries that have a need for modeling plasmas:



Semiconductor



To fabricate microchips.



Electrical breakdown.



Reactive gas generators.

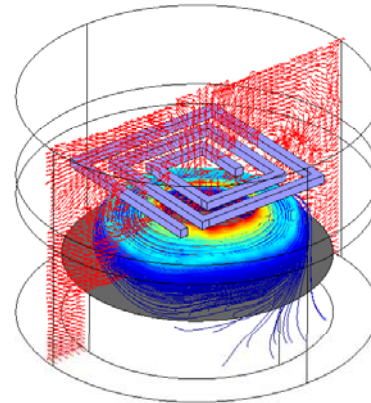

Lighting



Long life, energy efficient bulbs.



Plasma and LCD TV's.



Plasma lamps.

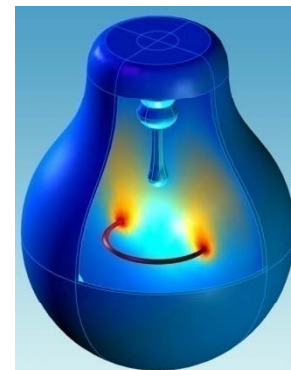

Applications Covered by the Plasma Module

- Industries that have a need for modeling plasmas:

Medical



Fast and potent sterilization of syringes, etc.



Kill bacteria embedded in teeth.



Wound treatment.



Other

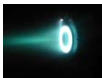

Space thrusters.



Impermeable coatings.



Plasma torches.

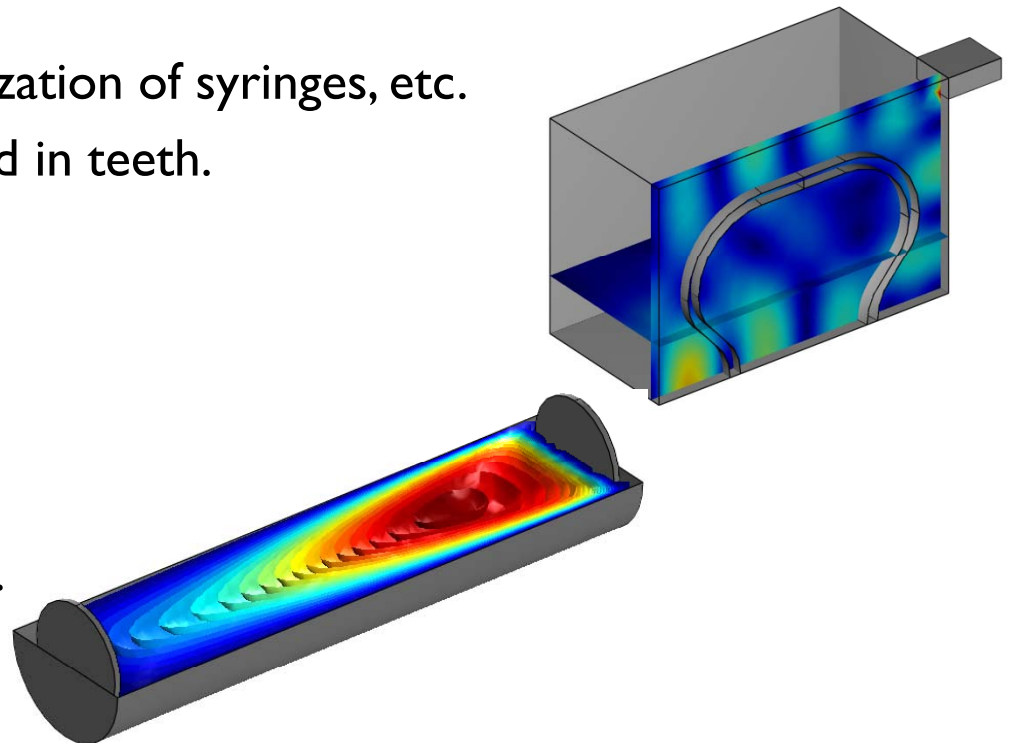

Predefined Couplings

- The Plasma Module will include predefined couplings for the most common types of reactors:

- Inductively Coupled Plasma (ICP)
- Capacitively Coupled Plasma (CCP)
- Microwave plasmas
- DC discharges

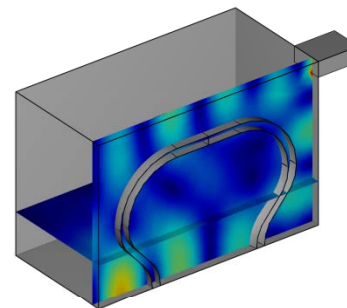
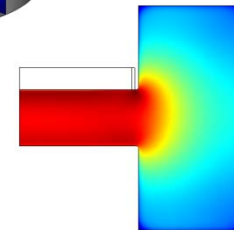
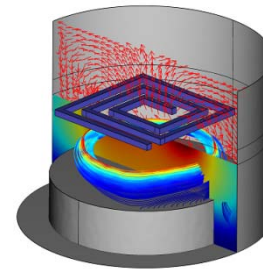

Supporting Capabilities in COMSOL Multiphysics®

- RF and AC/DC Modules:
 - RF Module to model plasmas sustained by electromagnetic waves
 - AC/DC Module to model plasmas sustained by induction currents
- Other Physics:
 - Heat transfer, structural mechanics and fluid flow
 - Arbitrary equations for flexibility
- CAD capabilities:
 - Include designs with the CAD Import Module

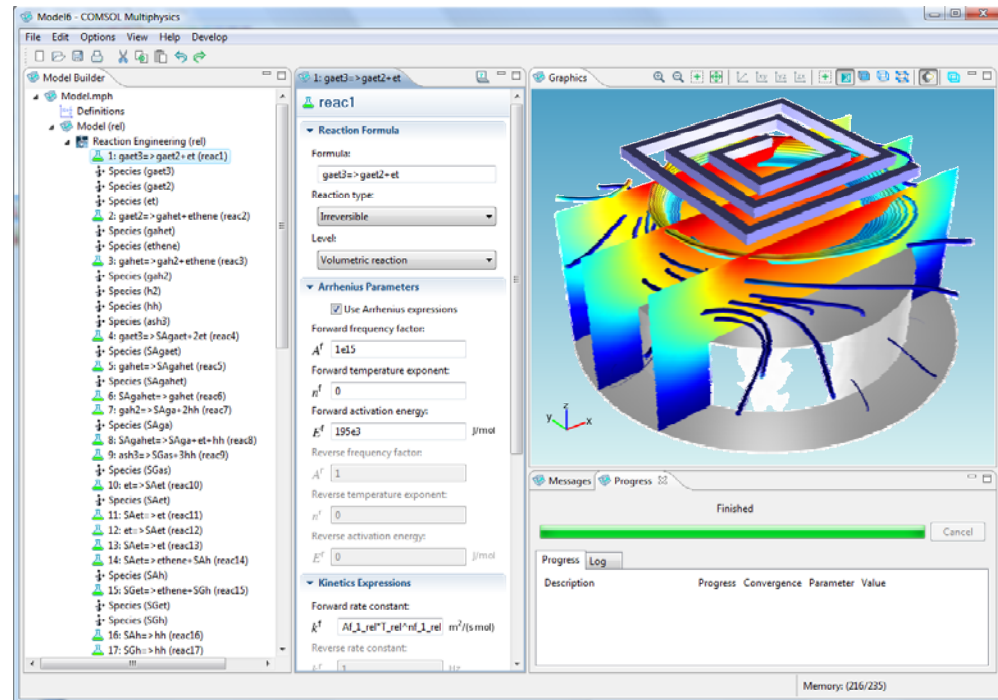

3D ICP reactor

Coming up next

- V4 to be released in March 2010
- Three new modules in June 2010
- Application Programming Interface (API) 2010
- Physics Interfaces with built-in Optimization